

QuCube for Milesight UR41

INTEGRATED MULTI-BAND LTE & 5G OMNI ANTENNA + GPS ANTENNA + PASSIVE POE SPLITTER + PLACE TO INSTALL MILESIGHT UR41 (ALL-IN-ONE)

QuCube for Milesight UR41 is a revolutionary outdoor antenna solution that combines minimized dimensions with exceptional antenna performance. Designed specifically as an **antenna for Milesight UR41 router**, it delivers reliable, high-speed wireless connectivity in even the most demanding environments.

This all-in-one unit integrates high-gain omnidirectional **5G and GPS antennas** with Milesight routers into a compact, rugged **IP68-rated waterproof enclosure**. The integration reduces installation complexity while enabling rapid deployment of advanced outdoor 5G solutions.

Engineered for outdoor and mobile applications, **QuCube** is ideal for use in transportation systems, for underground connectivity or urban and public installations. It ensures consistent performance wherever dependable connectivity is essential.

The set contains a [Passive PoE splitter](#), allowing you to split data and power from a single Ethernet cable and maintain gigabit transfer speeds while protecting the LAN port from damage caused by overvoltage, short circuit or improper connection. **NOTE:** should only be used with a 24V (or lower voltage) Passive PoE power supply it is not compatible with an 802.3af/at power source!

5G
617-6000MHz
4 dBi **GPS**
OMNI
DIRECTIONAL
IP 68
-40° TO +80°

OUTDOOR ANTENNA WORKS IN **ANY**
WEATHER CONDITIONS, IP68



ANTENNA **PERFECTLY MATCHED** WITH
THE ROUTER



MADE IN **EUROPE**

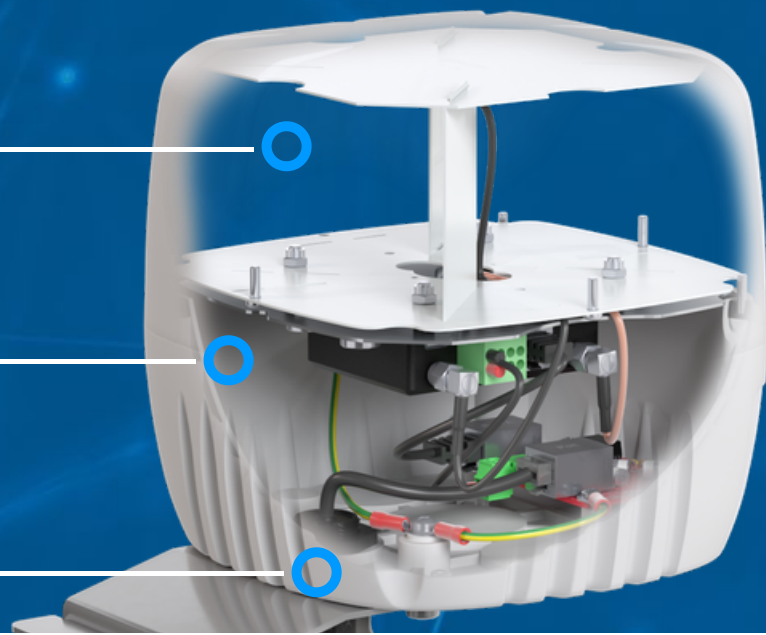

5G/LTE SPECIFICATION

FREQUENCY	617 - 960 MHz 1.7 - 2.7 GHz 3.3 - 6.0 GHz
GAIN	617 - 960 MHz : 2 dBi 1.7 - 2.7 GHz : 3 dBi 3.3 - 6.0 GHz : 4 dBi
SUPPORTED LTE BANDS	1, 2, 3, 4, 5, 7, 8, 9, 10, 12, 13, 14, 17, 18, 19, 20, 22, 25, 26, 27, 28, 29, 30, 33, 34, 35, 36, 37, 38, 39, 40, 41, 42, 43, 44, 46, 47, 48, 49, 52, 53, 65, 66, 67, 68, 69, 71, 85, 103, 106
SUPPORTED 5G BANDS	n1, n2, n3, n5, n7, n8, n12, n13, n14, n18, n20, n25, n26, n28, n29, n30, n34, n38, n39, n40, n41, n46, n47, n48, n53, n65, n66, n67, n71, n77, n78, n79, n80, n81, n82, n83, n84, n85, n86, n89, n90, n95, n97, n98, n100, n101, n256
VSWR	<1.20, max <2.50
BEAMWIDTH	360°/35° ±5°
POLARIZATION	Vertical
IMPEDANCE	50 Ω

MECHANICAL SPECIFICATION

MATERIAL	ABS
CONNECTOR	QuRJ45
OUTER DIMENSIONS	160 x 160 x 155 mm 6.3 x 6.3 x 6.10 inch
WEIGHT	1.5 kg
OPERATING TEMPERATURE	-40°C to 80°C -40°F to 176°F
INGRESS PROTECTION	IP67 and IP68

MOUNTING KIT

MATERIAL	Galvanized steel
WEIGHT	0.4kg
MOUNTING PLACE	Wall or mast
MAST DIAMETER	25-66 mm 0.98-2.60 inch

PLOTS

5G/LTE VSWR

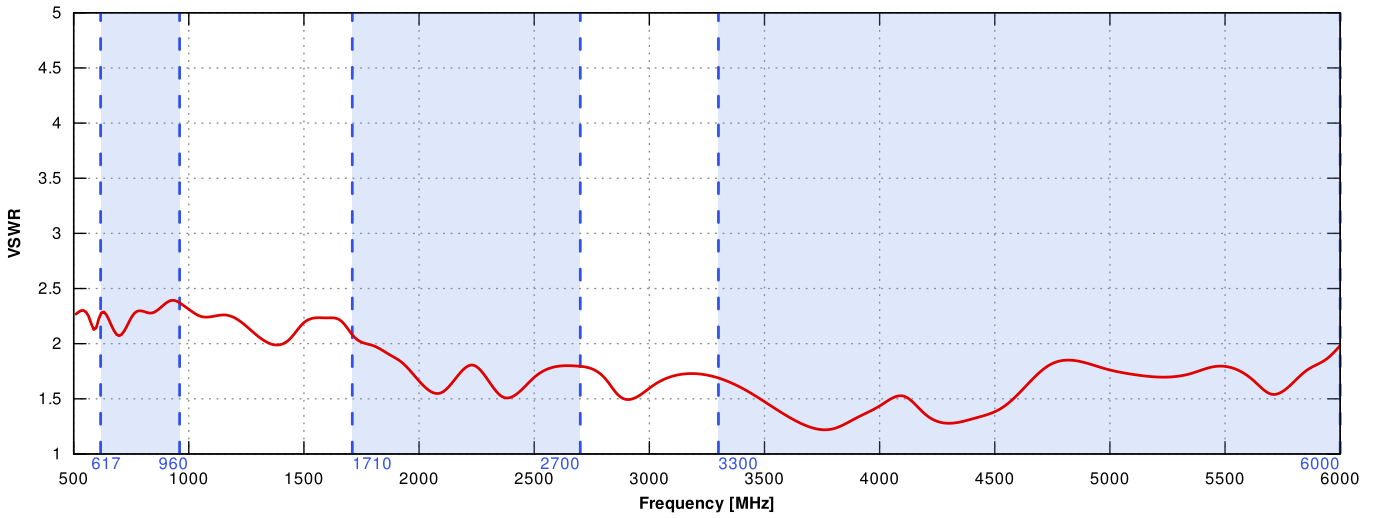

5G/LTE GAIN

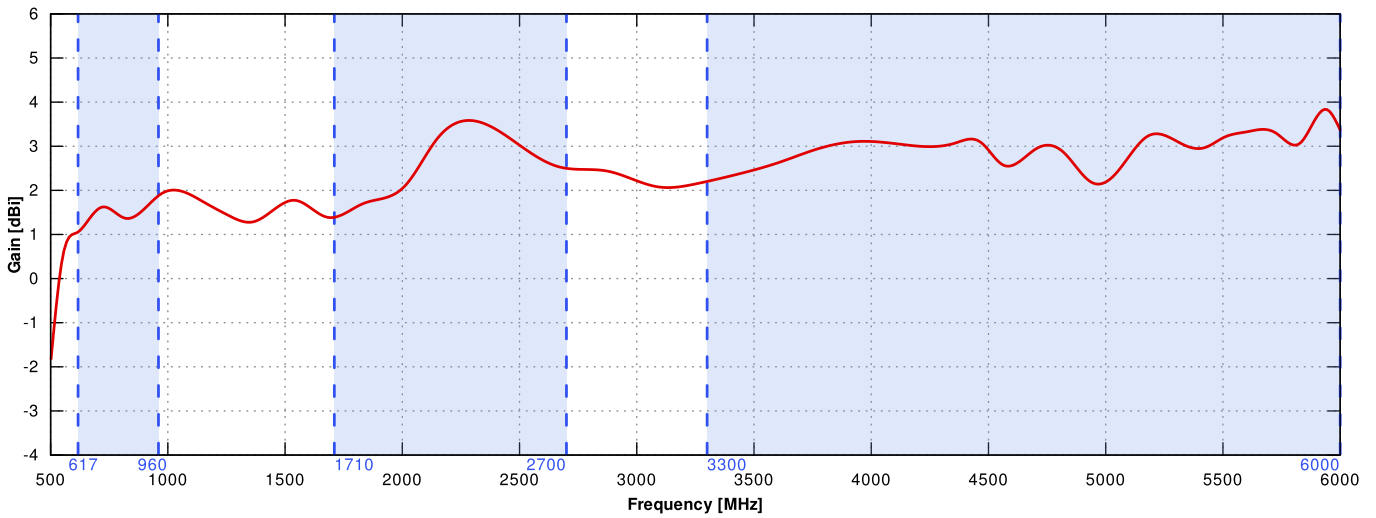

5G/LTE from 617MHz to 960MHz

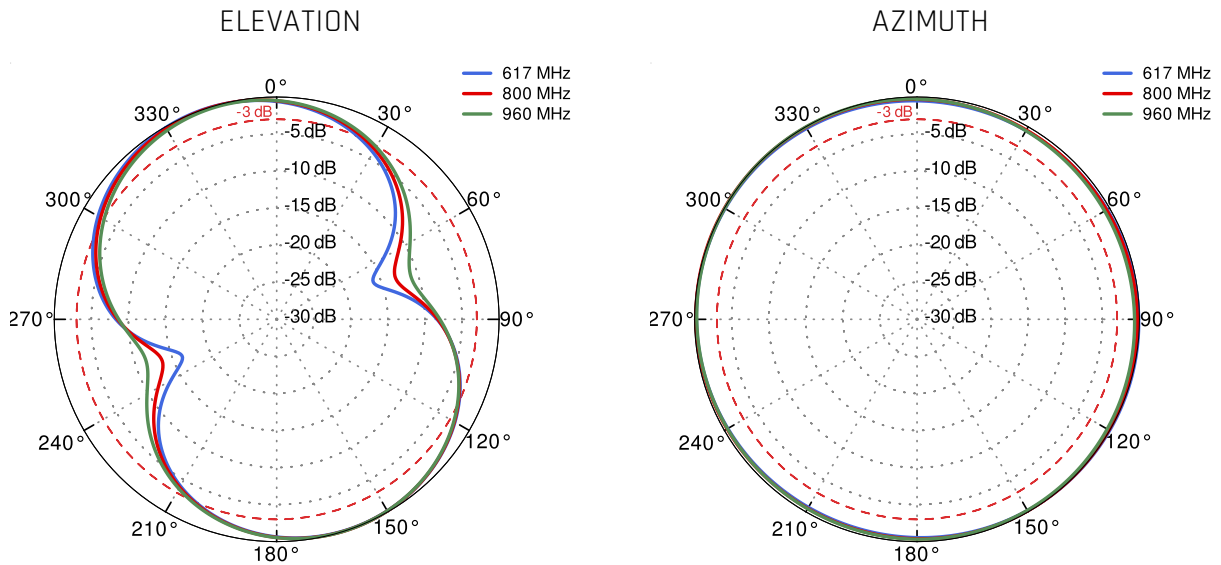

5G/LTE from 1.71GHz to 2.7GHz

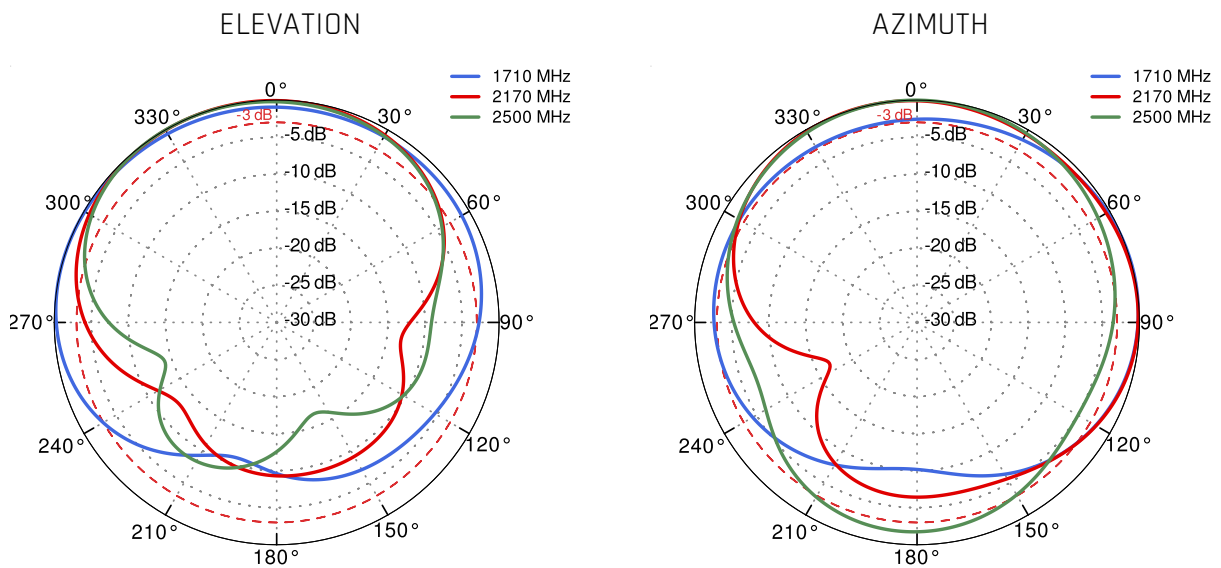

5G/LTE from 3.3GHz to 4.2GHz

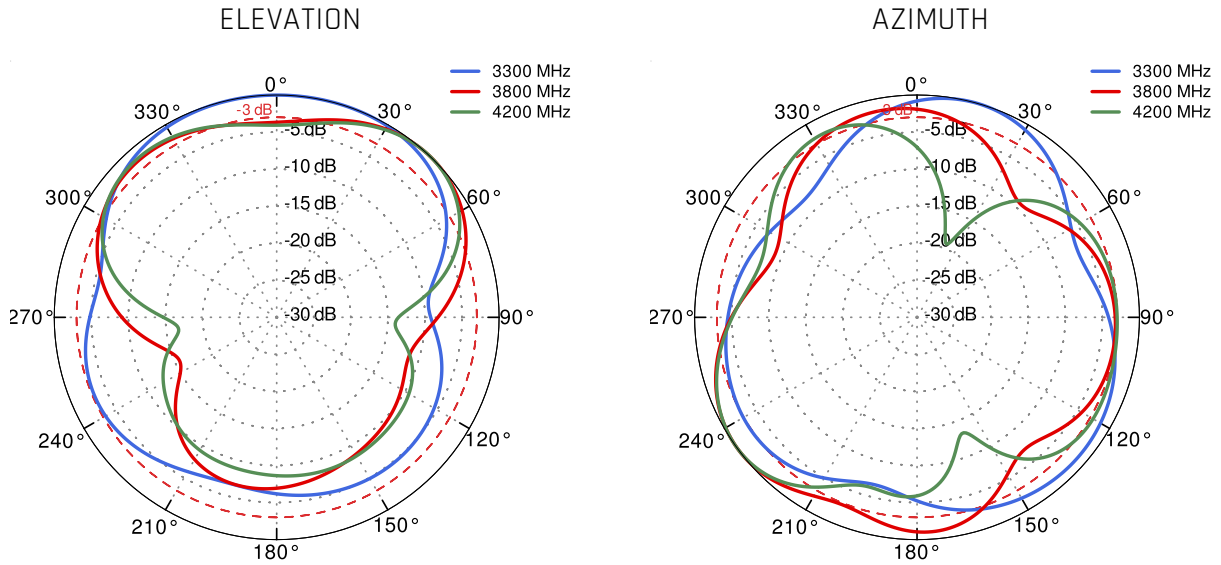

5G/LTE from 4.8GHz to 5.8GHz

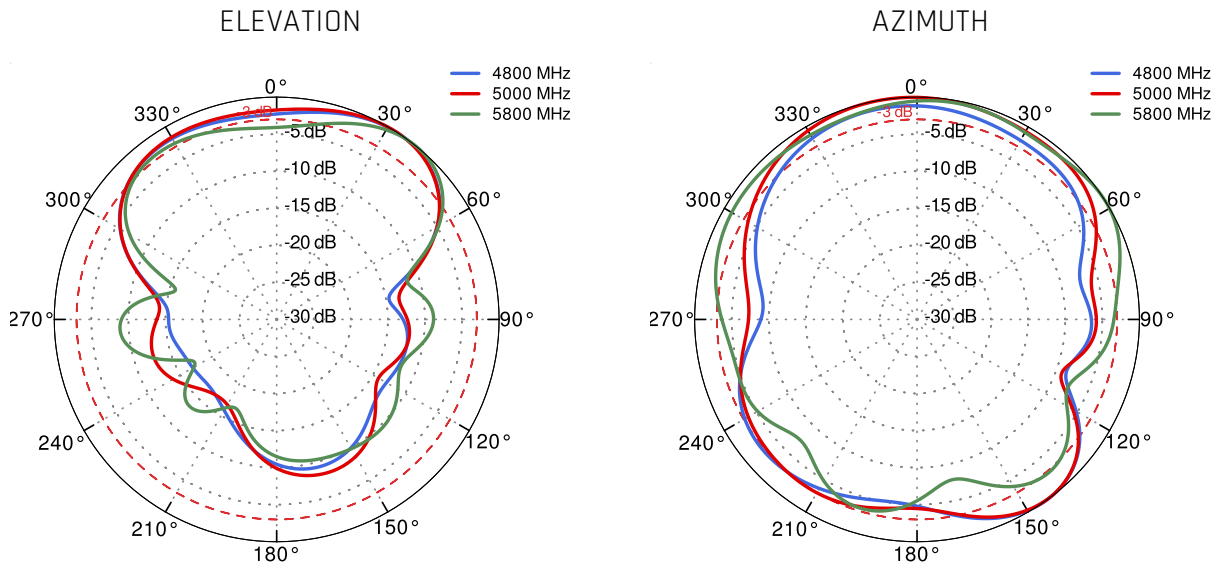

DIMENSIONS

