

# QuSpot for Perle IRG5410

## INTEGRATED MULTI-BAND 5G OMNI ANTENNA + GPS ACTIVE ANTENNA + POE SPLITTER + PLACE TO INSTALL PERLE IRG5410 (ALL-IN-ONE)

QuSpot antenna for Perle IRG5410 router is a perfect outdoor device for mobile and fixed installations like industrial, CCTV, hotspots, yachts, boats, campers, RV etc. It has embedded omni 5G and GPS antenna. If you use IRG5410 with QuSpot antenna, you get an integrated complete solution with embedded router and multi band antennas in one enclosure.

The set contains a [Passive PoE splitter](#), allowing you to split data and power from a single Ethernet cable and maintain gigabit transfer speeds while protecting the LAN port from damage caused by overvoltage, short circuit or improper connection.



OUTDOOR ANTENNA WORKS IN **ANY WEATHER CONDITIONS**, IP68



WIDE BAND 600-6000MHZ, 5G TECHNOLOGY



ALL ANTENNAS AND PERLE ROUTER INTEGRATED IN ONE ENCLOSURE



GALVANIZED STEEL, WALL OR POLE MOUNTING BRACKET



MADE IN **EUROPE**

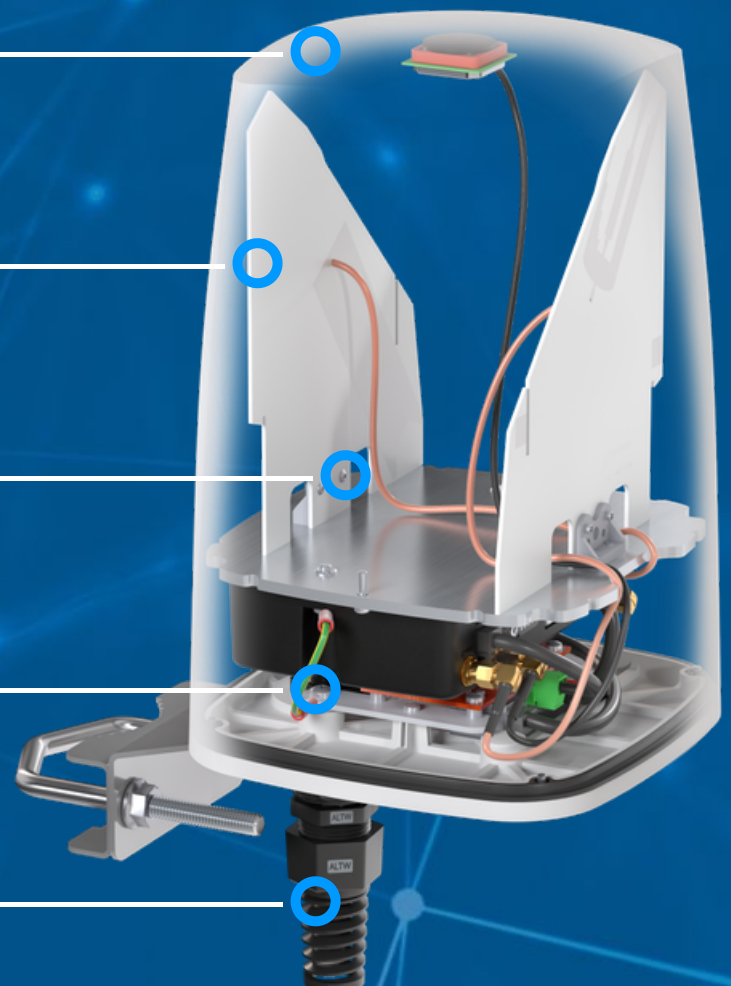

## 5G / LTE ANTENNA SPECIFICATION

<b>FREQUENCY</b>	617 - 960 MHz 1.7 - 2.7 GHz 3.3 - 4.7 GHz 5.2 - 6.0 GHz
<b>GAIN</b>	617 - 960 MHz : 3 dBi 1.7 - 2.2 GHz : 4 dBi 3.3 - 4.7 GHz : 4.5 dBi 5.2 - 6.0 GHz : 2.5dBi
<b>SUPPORTED LTE BANDS</b>	1, 2, 3, 4, 5, 7, 8, 9, 10, 12, 13, 14, 17, 18, 19, 20, 22, 25, 26, 27, 28, 29, 30, 33, 34, 35, 36, 37, 38, 39, 40, 41, 42, 43, 44, 47, 48, 49, 52, 53, 65, 66, 67, 68, 69, 71, 85, 103, 106
<b>SUPPORTED 5G BANDS</b>	n1, n2, n3, n5, n7, n8, n12, n13, n14, n18, n20, n25, n26, n28, n29, n30, n34, n38, n39, n40, n41, n47, n48, n53, n65, n66, n67, n71, n77, n78, n80, n81, n82, n83, n84, n85, n86, n89, n90, n95, n97, n98, n100, n101, n256
<b>VSWR</b>	<1.80, max <2.00
<b>BEAMWIDTH</b>	360°/35° ±5°
<b>POLARIZATION</b>	Vertical
<b>IMPEDANCE</b>	50 Ω
<b>CONNECTOR</b>	2x SMA

## GPS ACTIVE ANTENNA SPECIFICATION

<b>FREQUENCY</b>	1.56 - 1.61 GHz
<b>VSWR</b>	< 2
<b>GAIN</b>	3 dBi
<b>GAIN 3V</b>	28 dBi
<b>DC POWER INPUT</b>	2.5 V ~ 6.5 V
<b>POWER CONSUMPTION</b>	2.5-6.5mA
<b>IMPEDANCE</b>	50 $\Omega$
<b>POLARIZATION</b>	RHCP (right hand circularly polarized)
<b>CONNECTOR</b>	1x SMA

## MECHANICAL SPECIFICATION

<b>MATERIALS</b>	ABS, aluminum, PTFE
<b>CONNECTOR TYPE</b>	RJ45
<b>INGRESS PROTECTION</b>	IP68
<b>DIMENSIONS</b>	160 x 160 x 240 mm 6.3 x 6.3 x 9.45 inch
<b>OPERATING TEMPERATURE</b>	From -40°C to 80°C From -40°F to 176°F
<b>ENCLOSURE RECOMMENDED TIGHTENING TORQUE</b>	0.5 - 0.7 Nm

**MAST DIAMETER**

 25-66 mm  
 0.98-2.60 inch

**FREQUENCY BANDS**
**LTE / 4G**

	1	2	3	4	5	7	8	
	9	10	12	13	14	17	18	
	19	20	22	25	26	27	28	
617 MHz	29	30	33	34	35	36	37	6000 MHz
	38	39	40	41	42	43	44	
	47	48	49	52	53	65	66	
	67	68	69	71	85	103	106	

**5G**

	n1	n2	n3	n5	n7	n8	n12	
	n13	n14	n18	n20	n25	n26	n28	
	n29	n30	n34	n38	n39	n40	n41	
617 MHz	n47	n48	n53	n65	n66	n67	n71	6000 MHz
	n77	n78	n80	n81	n82	n83	n84	
	n85	n86	n89	n90	n95	n97	n98	
	n100	n101	n256					

# PLOTS

## 5G/LTE VSWR

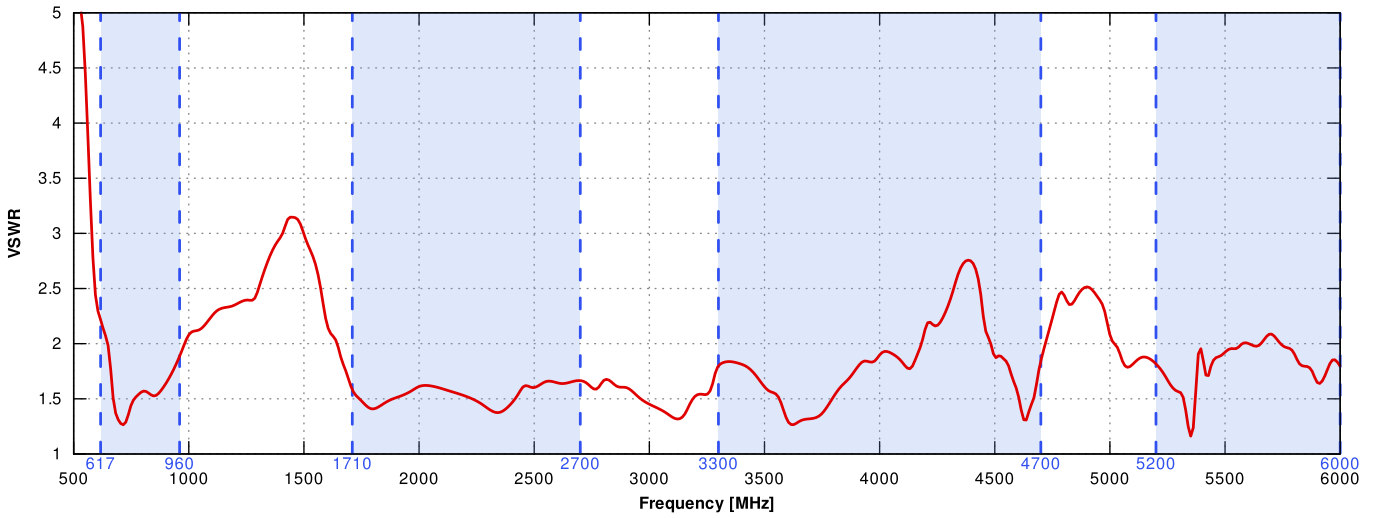

## 5G/LTE Gain

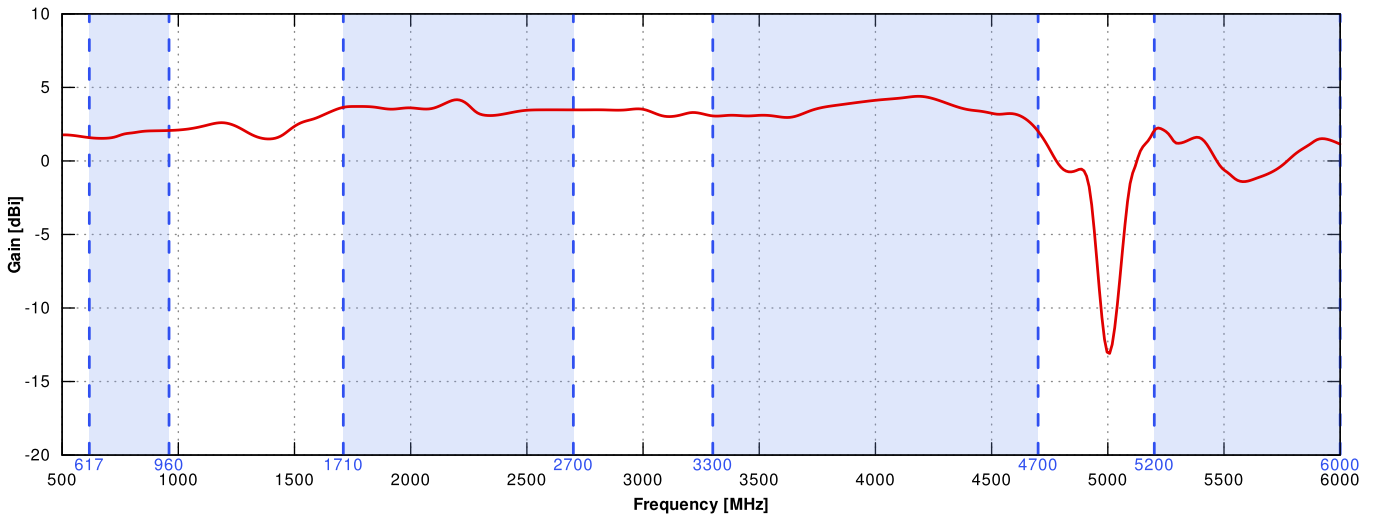

### 5G/LTE From 617MHz to 960MHz

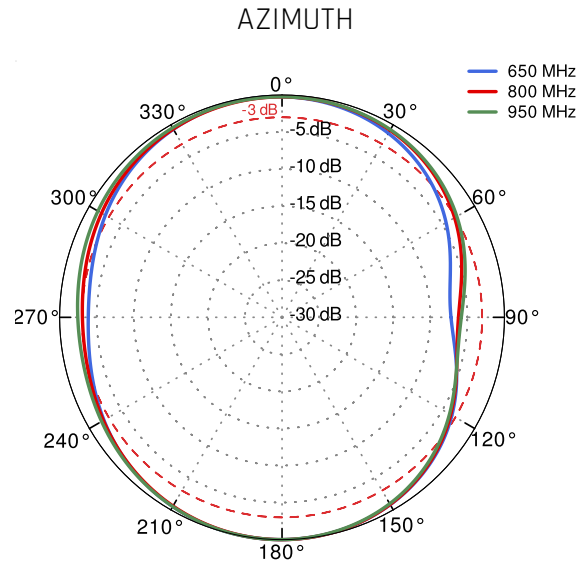
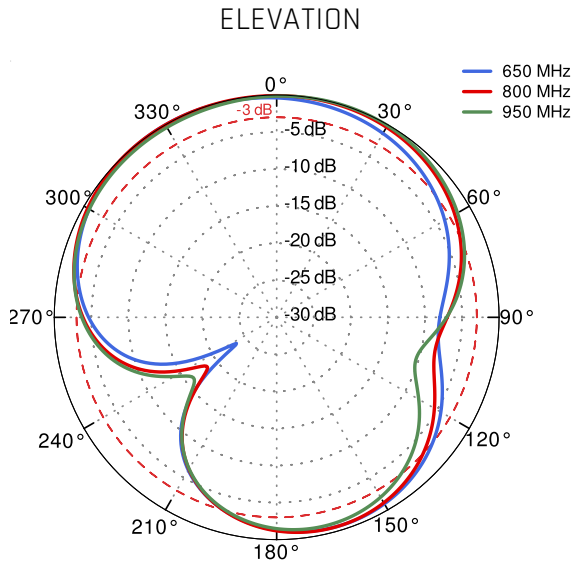

### 5G/LTE From 1.71GHz to 2.5GHz

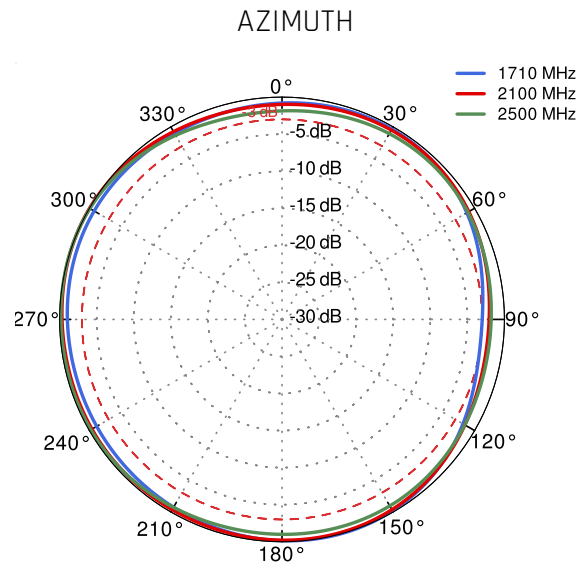
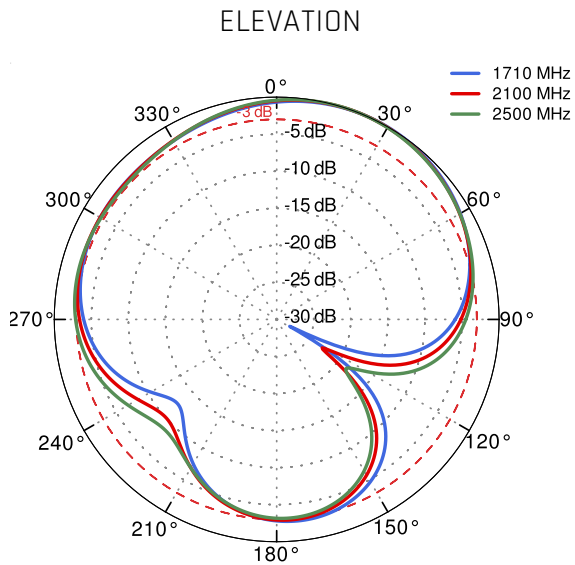

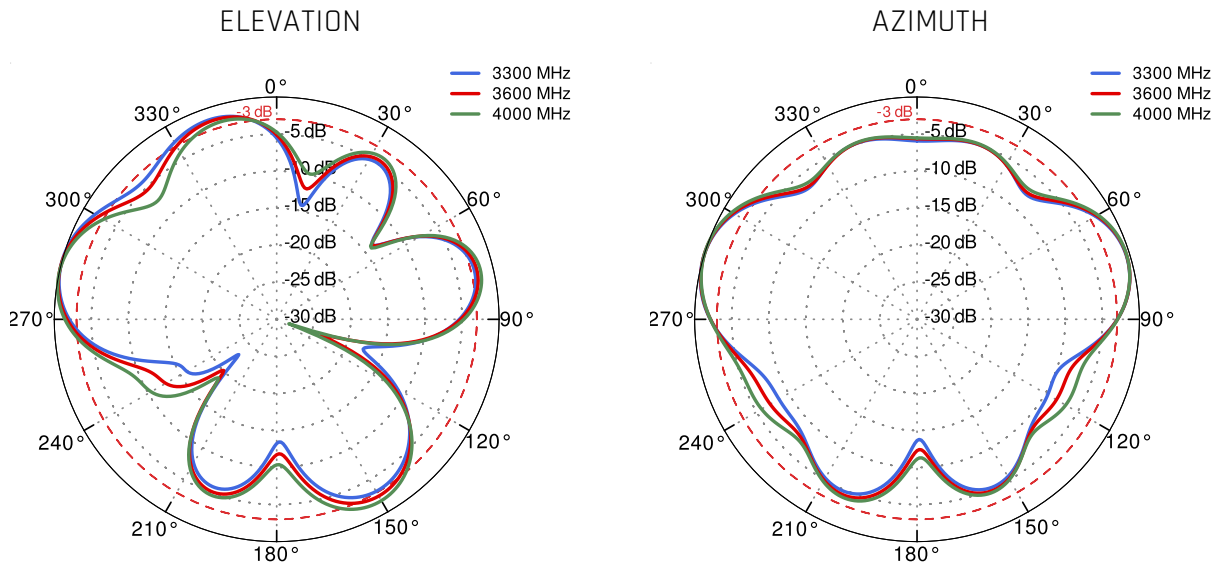
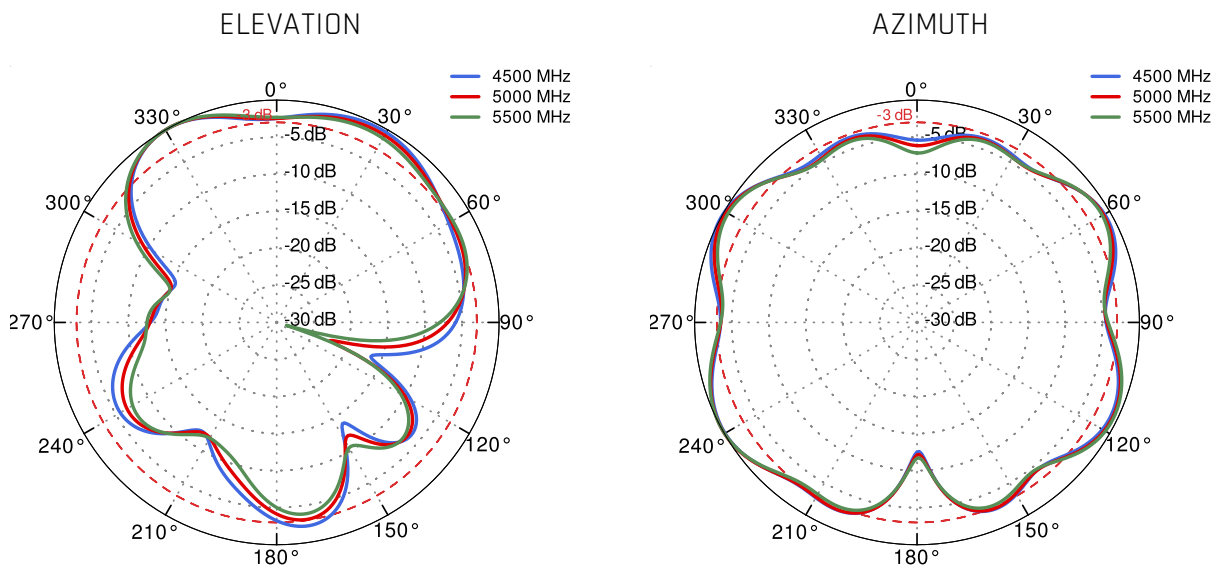
**5G/LTE From 3.3GHz to 4.2GHz**

**5G/LTE From 4.5GHz to 5.5GHz**

## **DIMENSIONS**

